

Bedienungsanleitung

Containerschrank Yente



Werkzeuge



Brett 135 x 16 mm

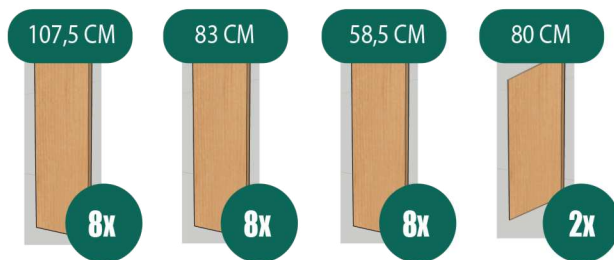

Balken 67 x 44 mm

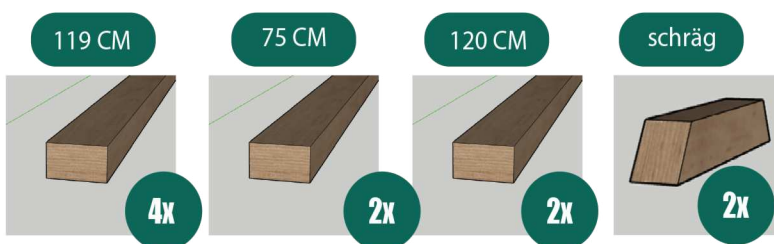

Balken 44 x 44 mm

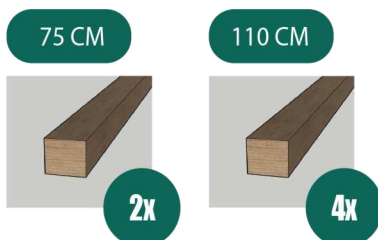

Schweden rabatt



Anweisungen

Überprüfen Sie alle Teile auf dieser Teilleiste vor der Montage. Beginnen Sie nicht mit der Montage, wenn Teile fehlen.

Lesen Sie die Montageanleitung sorgfältig durch und folgen Sie den einzelnen Schritten für eine ordnungsgemäße Montage.

Für einen optimalen Schutz der Materialien empfehlen wir, das Produkt auf einer ebenen und festen Unterlage zu platzieren.

Kleinteile

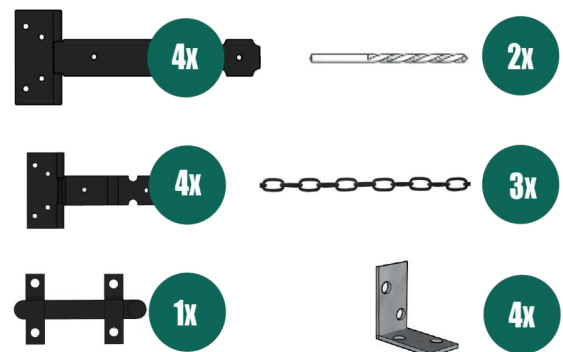

Schrauben und Dübel

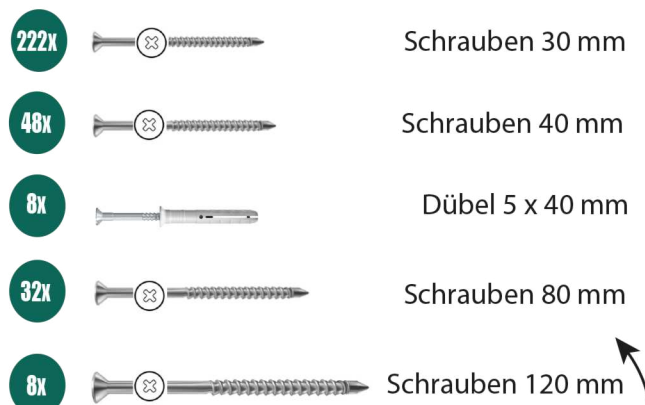

! Alle Schrauben vorbohren

INSTALLATIONS PLAN

Montageschritt 1

- 2x Balken 67x44mm 119 cm
- 1x Balken 44x44mm 75 cm
- 4x Schrauben 80 mm

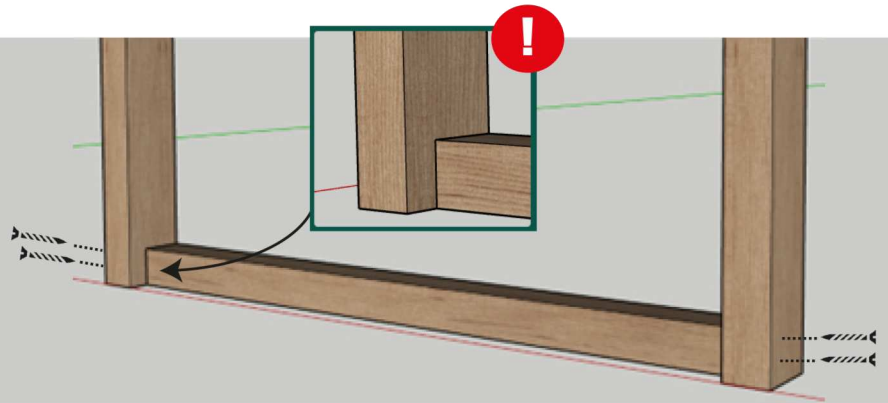

Montageschritt 2

- 1x Balken 67x44mm 75 cm
- 4x Schrauben 80mm

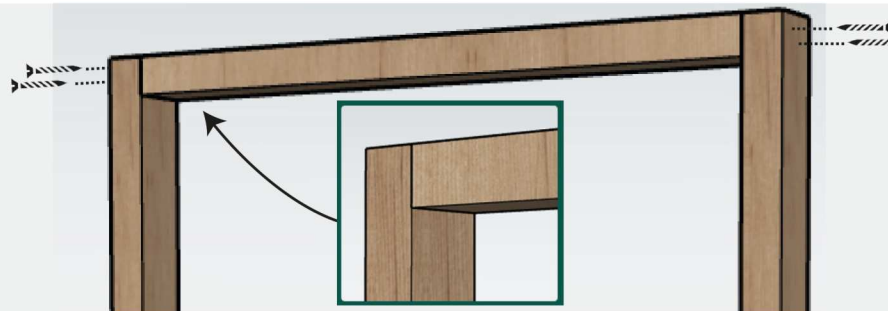

Montageschritt 3

- 2x Balken 44x44mm 110 cm
- 6x Schrauben 80mm

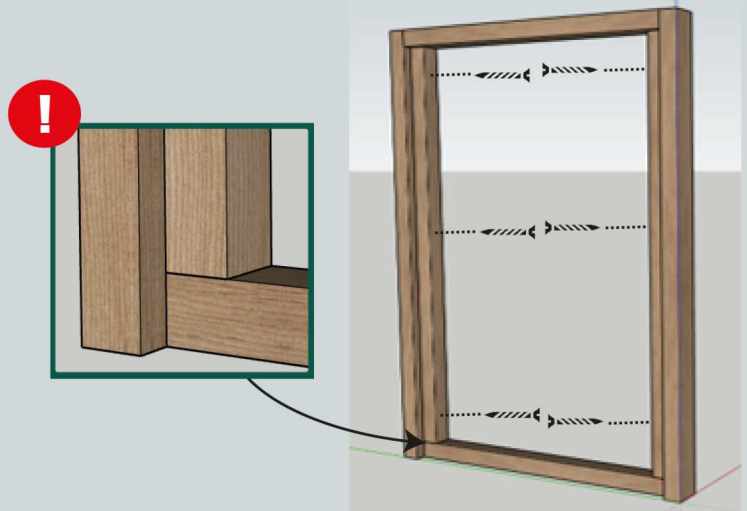

Montageschritt 4

- 1x Schweden rabatt 74,8 cm
- 4x Schrauben 40mm

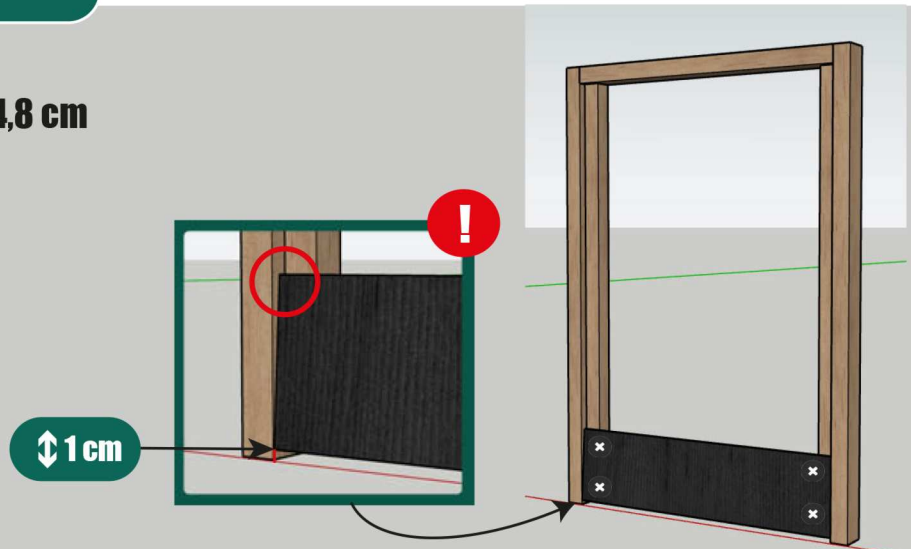

INSTALLATIONS PLAN

Montageschritt 5

- 5x Schweden rabatt 74,8 cm
- 20x Schrauben 40mm

! Verteilen Sie die Dielen über die gesamte Höhe

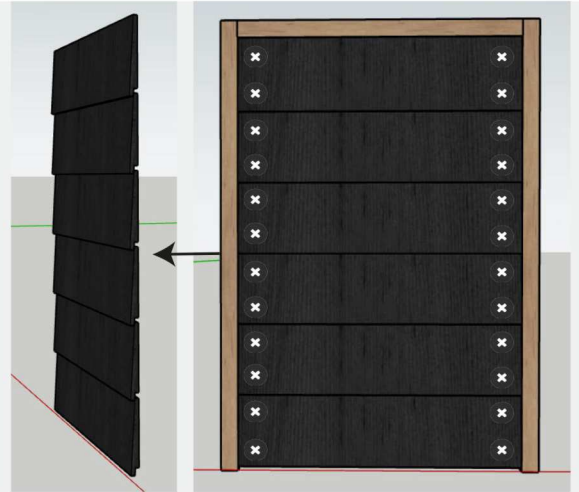

Montageschritt 6

Wiederholen Sie die Schritte 1 bis 5, um 2 identische Panels zu erhalten

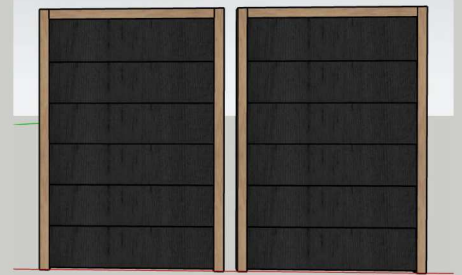

Montageschritt 7

- 1x Balken 67x44mm 120 cm
- 4x Schrauben 120mm

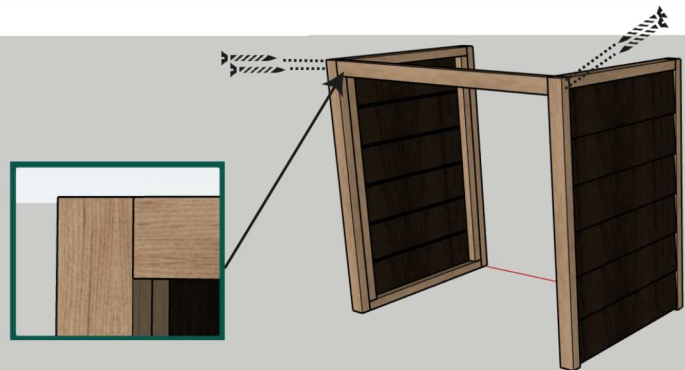

Montageschritt 8

- 1x Balken 67x44mm 120 cm
- 4x Schrauben 120mm

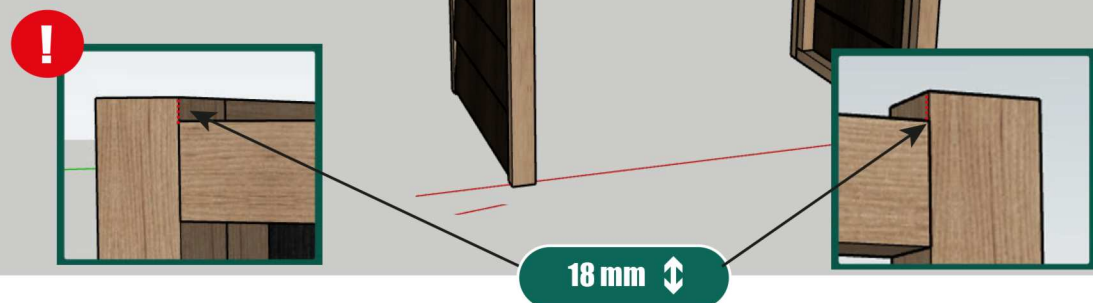

INSTALLATIONS PLAN

Montageschritt 9

- 4x Stuhlwinkel
- 8x Dübel 40mm
- 8x Schrauben 30mm

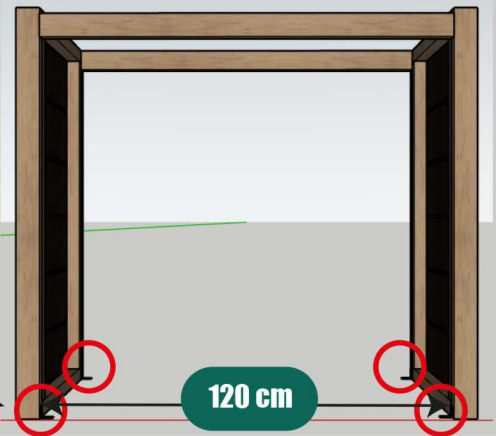
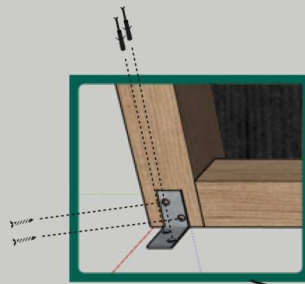

Montageschritt 10

- 8x Brett 135x16mm 83cm
- 4x Brett 135x16mm 58,5cm
- 64x Schrauben 30mm

10 cm

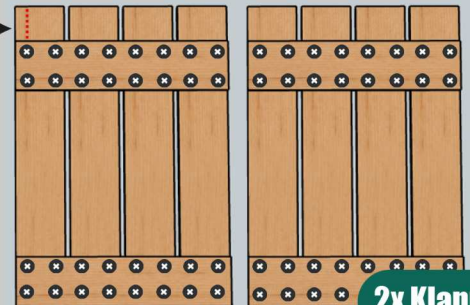

2x Klappe

Montageschritt 11

- 8x Brett 135x18mm 107,5cm
- 4x Brett 135x18mm 58,5cm
- 2x Brett 135x18mm 80cm (Schräge)
- 92x Schrauben 30mm

10 cm

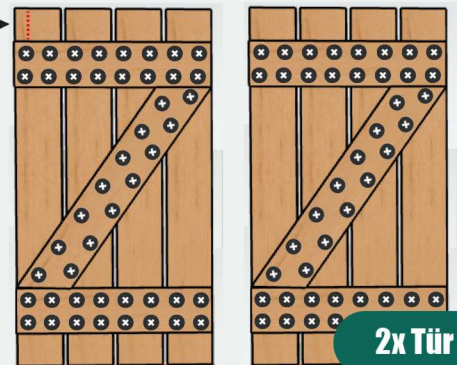

2x Tür

Montageschritt 12

- 3x Klappe
- 4x Scharnier Kurz
- 24x Schrauben 30mm

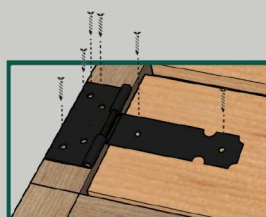

INSTALLATIONS PLAN

Montageschritt 13

- 2x Tür
- 4x Scharnier Lang
- 1x Schloss
- 32x Schrauben 30mm

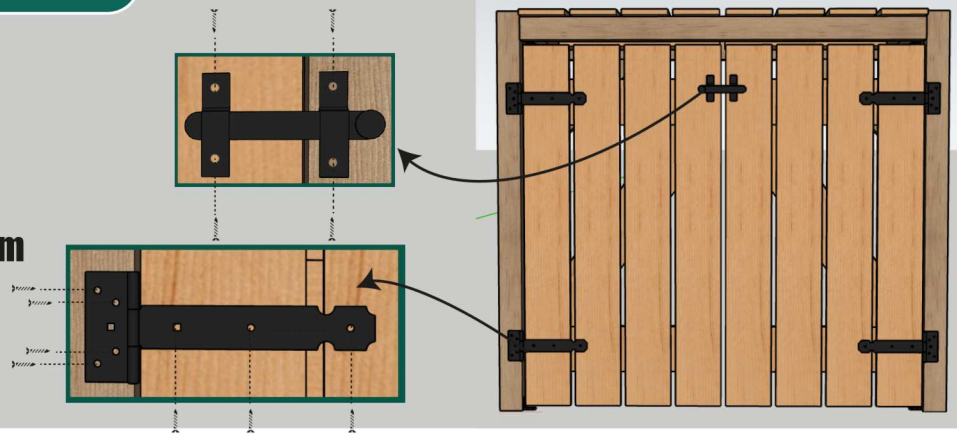

Montageschritt 14

- 2x Balken 44x44 (Schräge)
- 4x Schrauben 80 mm

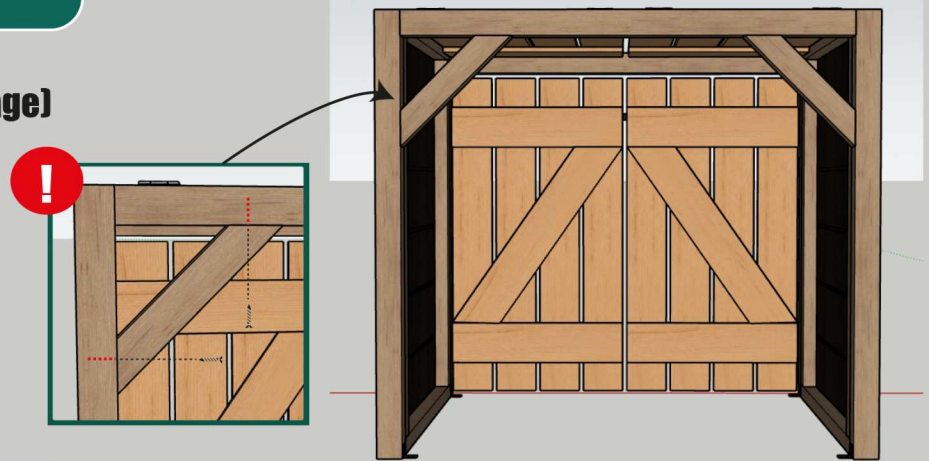

Montageschritt 15

- 2x Kette
- 2x Schrauben 30mm

